

Mardi 20 novembre 2012

Le rectangle et le carré

Exercice n° 1 p. 52 :

a)

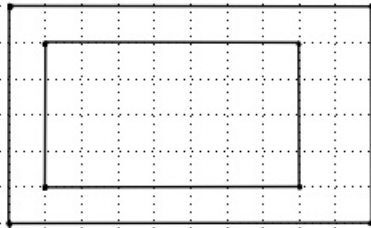

b)

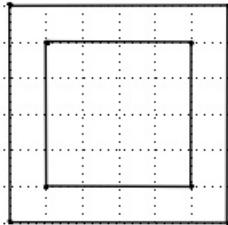

Exercice n° 2 p. 52 :

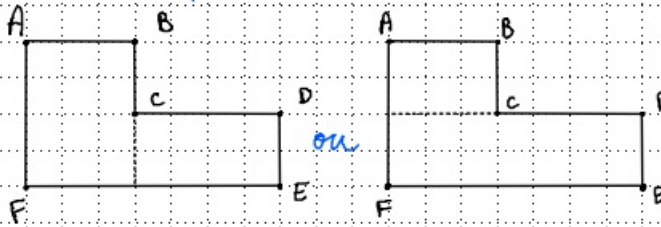

Exercice n° 3 p. 52 :

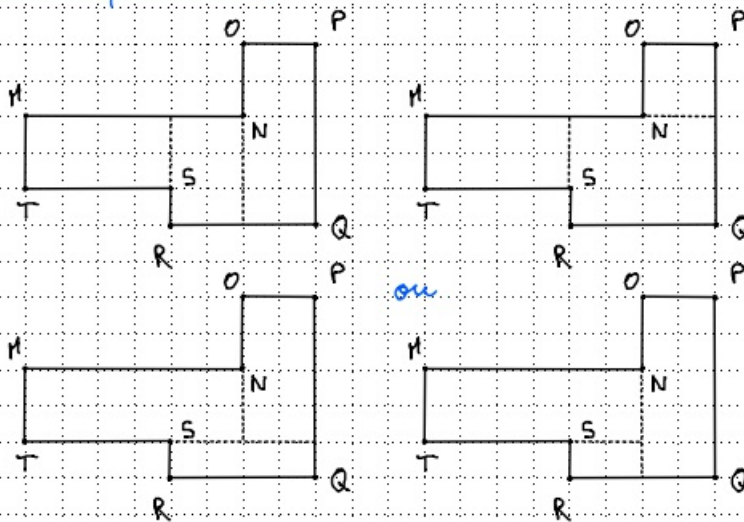

## Symétrie axiale (1)

Exercice n° 1 p. 54 :

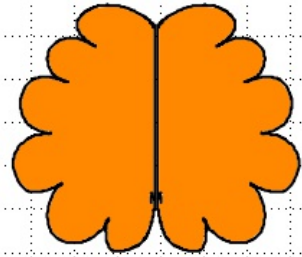
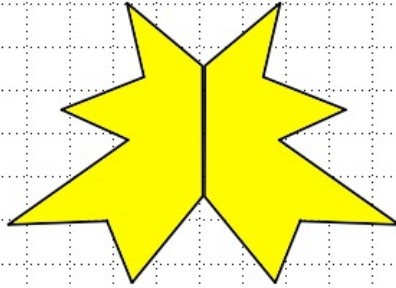
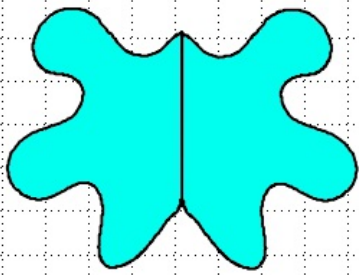

Exercice n° 2 p. 53 :

